



Anchors, micropiles and soil nailing

Flexible solutions to transfer tensile and/or compression loads, even in challenging situations.

Geotechnical solutions for the construction industry



Systems

There are two anchor systems available worldwide: strand and bar anchors.

Strand anchors consist of several strands (typically three to 15 strands per anchor), with steel cross sections of 100 – 150mm² and steel grades up to 1,860N/mm².

Bar anchors consist of high graded solid bars with a diameter from 18 to 47mm and a steel grade up to 1,050N/mm².

Anchors can be temporary (lasting for less than two years) or permanent (lasting for more than two years).

If required, removable anchors allow for almost all the steel components to be removed from the surrounding ground.

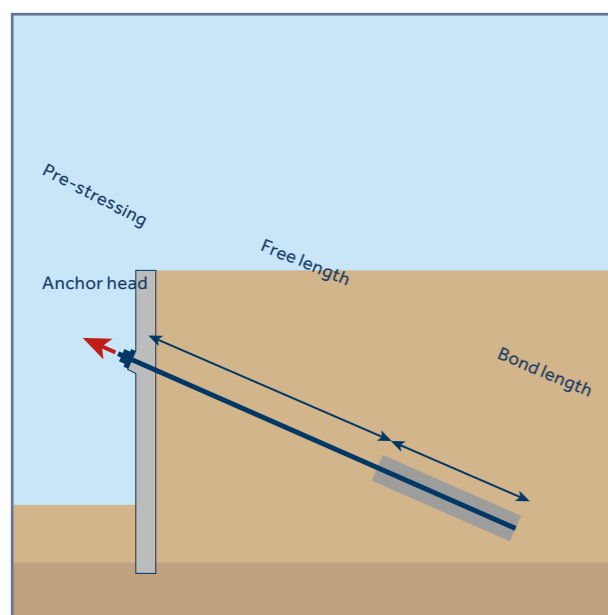

Anchors (EN 1537)

- Can be used to transfer tensile loads
- Consist of an anchor head, a free length, and a bond length
- The free length means they have to be pre-stressed, a big benefit when constructing very deep excavation pits with low horizontal deflections
- Operate as a single load transferring element
- If a load transferring element has a free length, then it is an anchor and not a micropile

Overview

Anchors, bored micropiles and soil nailing are flexible solutions for transferring tensile and/or compression loads, even in challenging situations such as low headroom, steep slopes or deep excavation pits.

Execution involves small diameter drilling of a borehole, installation of the tension elements and grouting to fix them into the ground.

All pre-stressed anchors have to be tested according to national and international regulations and special measures are required to test two to three percent of all micropiles and soil nails.

Micropiles (EN 14199)

- Can be used to transfer tensile, compression and / or alternating loads
- Have a diameter less than 300mm
- When inclined vertically or slightly inclined, can be used to transfer compression loads
- When inclined almost horizontally, can be used as tensile transferring elements to support excavation pits
- Are bonded with the surrounding soil over their entire length so can't be pre-stressed
- Operate as a single load transferring element

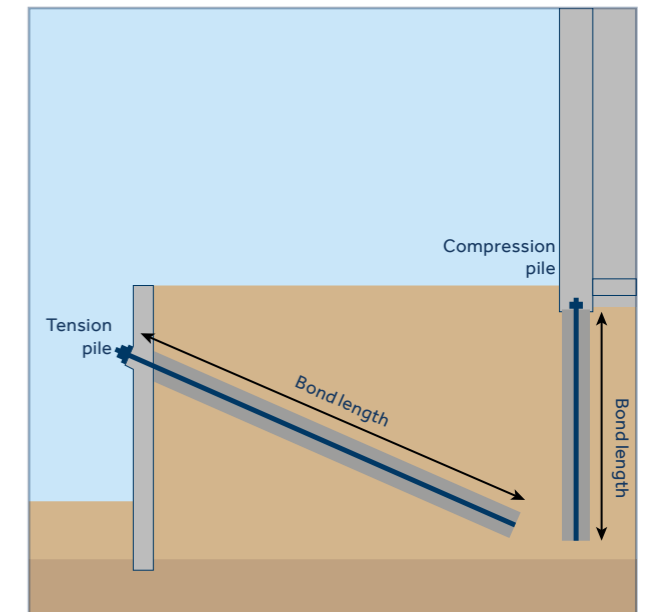

Soil nails (EN 14490)

- Are a composite bearing system made of soil nails and the surrounding soil
- Operate as group of elements, similar to soil reinforcement
- Bonded over their entire length, they have to be drilled in a narrow grid (with a maximum distance of around 1.5m in soil)

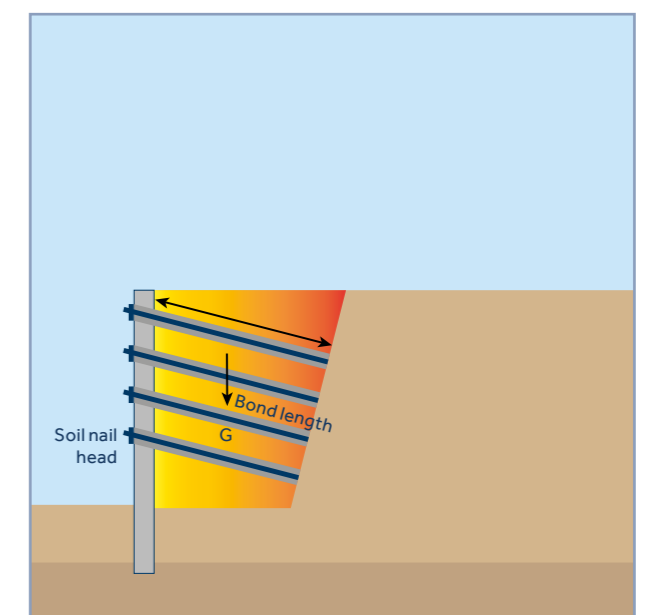



Anchors

Systems

Keller offers a wide variety of drilled micropile systems (solid bar, hollow bar and steel tube) and some driven micropile systems (Keller ductile piles, MESI piles, etc).

Our strand anchors consist of 3 to 15 strands with steel grades up to 1,860N/mm² while the pre-stressed bar anchor has a diameter of 18 – 47mm with a steel grade up to 1,050N/mm².

Due to the high steel grade, permanent anchors have to be assembled using a double corrosion protection (DCP) system.

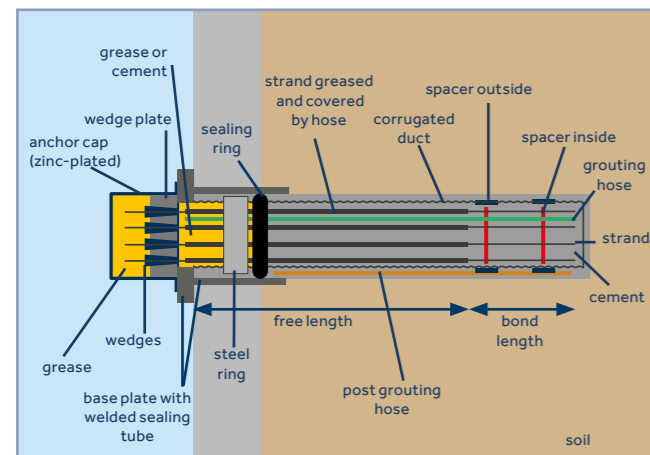

Pre-stressed permanent strand anchors (simplified)

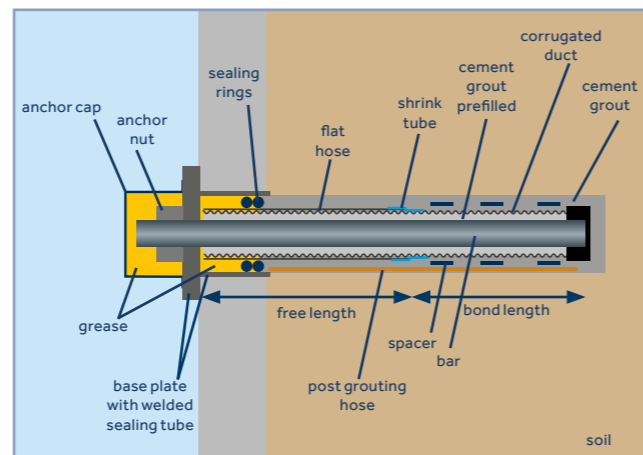

Pre-stressed permanent bar anchors (simplified)

If required, removable anchors allow that almost all steel components are removed from surrounding ground.

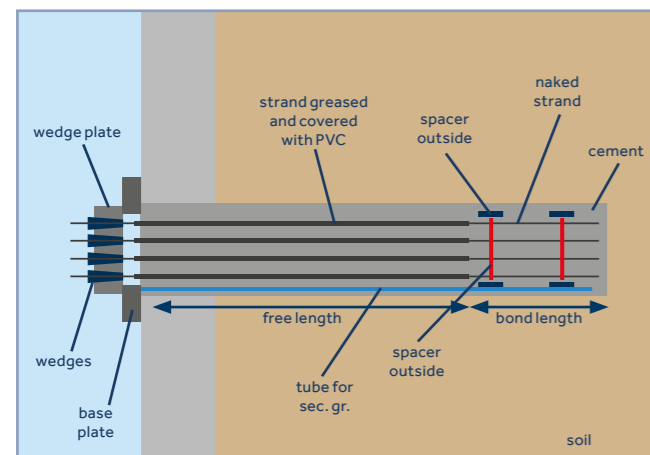

Pre-stressed temporary anchors

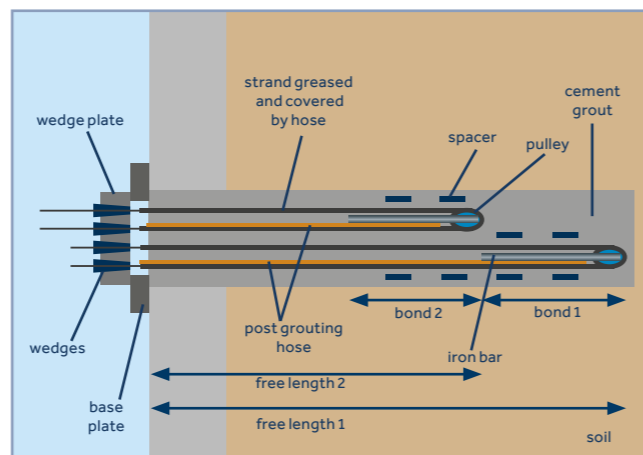

Pre-stressed removable strand anchors

Load capacity

STRAND ANCHORS Y1860 S7 – 15.7 MM						
No. of strands	$F_{pk} = 279 \text{ kN}, F_{p0.1k} = 246 \text{ kN}, S_{\sigma} = 150 \text{ mm}^2$					
	Load at permanent strain of 0.1% $R_{p0.1k}$ [kN]	Characteristic breaking load R_{pk} [kN]	Rated value of the anchor capacity according Damage consequence class $R_{Ed} = R_{p0.1k} / (1.15 * \eta)^{\text{II}}$		Max. test load P_p	
			CC 1 and CC 2, $\eta=1.0$ [kN]	CC 3, $\eta=1.15$ [kN]	$P_p < 0.90 * F_{p0.2}$ [kN]	$P_p < 0.80 * F_{pk}$ [kN]
2	492	558	428	372	446	443
3	738	837	642	558	670	664
4	984	1116	856	744	893	886
5	1230	1395	1070	930	1116	1107
6	1476	1674	1283	1116	1339	1328
7	1722	1953	1497	1302	1562	1550
8	1968	2232	1711	1488	1786	1771
9	2214	2511	1925	1674	2009	1993
10	2460	2790	2139	1860	2232	2214
11	2706	3069	2353	2046	2455	2435
12	2952	3348	2567	2232	2678	2657
13	3198	3627	2781	2418	2902	2878
14	3444	3906	2995	2604	3125	3100
15	3690	4185	3209	2790	3348	3321

According to Austrian regulations



Example of a strand anchor head (permanent)

BAR ANCHORS 950						
Diameter steel bar \varnothing mm	Load at permanent strain of 0.1% $R_{p0.1k}$ [kN]	Characteristic breaking load R_{pk} [kN]	Rated value of the anchor capacity according Damage consequence class $R_{Ed} = R_{p0.1k} / (1.15 * \eta)^{\text{II}}$		Max. test load P_p	
			CC 1 and CC 2, $\eta=1.0$ [kN]	CC 3, $\eta=1.15$ [kN]	$0.80 R_{pk}$ [kN]	$0.90 R_{p0.1k}$ [kN]
			18	230	255	200
26.5	525	580	457	397	464	473
32	760	845	661	575	676	684
36	960	1070	835	726	856	864
40	1190	1320	1035	900	1056	1071
47	1650	1820	1435	1248	1456	1485

According to Austrian regulations



Example of a bar anchor head (permanent)



Solid bar systems

There are a large variety of solid bar systems available in different diameters and steel grades, many of which have been established for years.

One of the most popular solid bar systems comprises fully-threaded bar elements, available

in diameters of 20 to 75mm with a steel grade of 550N/mm², and 18 to 75mm with a steel grade 670N/mm².

Execution involves small diameter drilling of a borehole, installation and grouting of the solid bar.

MICROPILES SAS 550 (threaded bar)							
Diameter steel bar Ø mm	Load at permanent strain of 0.2 % F _{p0.2} [kN]	Characteristic breaking load F _{pk} [kN]	Rated value of the pile capacity			Max. test load P _p	
			Steel capacity F _{pd} / 1.15 ¹¹ [kN]	CC1, CC2 η=1.3 [kN]	CC3, η=1.5 [kN]	P _p < 0.90 * F _{pd} [kN]	P _p < 0.80 * F _{pk} [kN]
20	175	195	152	117	101	158	156
25	270	304	235	181	157	243	243
28	340	382	296	227	197	306	306
32	440	499	383	294	255	396	399
40	693	781	603	464	402	624	625
50	1080	1215	939	722	626	972	972
57.5	1441	1818	1253	964	835	1297	1454
63.5	1760	2215	1530	1170	1020	1584	1772
75	2209	2430	1921	1478	1291	1988	1944

According to Austrian regulations

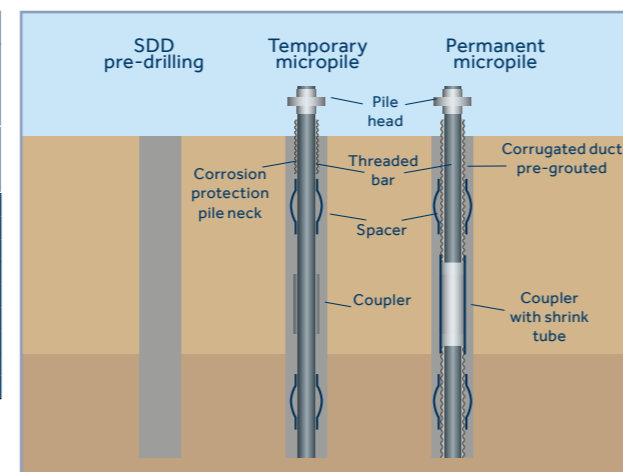

Micropile (threaded bar)

MICROPILES SAS 670 (threaded bar)						
Diameter steel bar Ø mm	Load at permanent strain of 0.2 % F _{p0.2} [kN]	Characteristic breaking load F _{pk} [kN]	Rated value of the pile capacity F _{pd} / 1.15 ¹¹ [kN]	CC1, CC2 η=1.3 [kN]	CC3, η=1.5 [kN]	Max. test load P _p
18	170	204	148	114	99	153
22	255	304	222	171	148	230
25	329	393	286	220	191	296
28	413	493	359	276	239	372
30	474	565	412	317	275	427
35	645	770	561	431	374	581
43	973	1162	846	651	564	876
50	1315	1570	1143	880	762	1184
57.5	1740	2077	1513	1164	1009	1566
63.5	2122	2534	1845	1419	1230	1910
75	2960	3535	2574	1980	1719	2664

According to Austrian regulations

Installation of solid bar systems consist of two steps:

1. Execution of small diameter drilling (SDD)
2. Installation and grouting of the solid bar

Micropiles & soil nails

Micropiles can be used to transfer both tension and / or compression loads. Soil nails transfer tension loads and act as a composite bearing system together with the surrounding soil.

Hollow bar systems

Hollow bar systems have been introduced over the last few decades. They are available in diameters from 32 to 108mm, with breaking loads up to 2,400kN.

They have the advantage that drilling and installation can be done simultaneously, resulting in high production rates and a very cost efficient solution. This bar system is not available with double corrosion protection according to EN 1537.

Diameter hollow bar Ø mm	Load at permanent strain of 0.2 % F _{p0.2} [kN]	Characteristic breaking load F _{pk} [kN]	Rated value of the anchor capacity according Damage consequence class R _{td} = F _{pd} / 1.15 ¹¹ / η		Max. test load P _p for soil nail test max. 0.90 * F _{pd} [kN]	Soil nails	Micropiles hollow bar
			CC 1, CC 2 η=1.3 [kN]	CC 3, η=1.5 [kN]			
H 0210-32	170	210	114	99	153		
H 0250-32	190	250	127	110	171		
H 0280-32	230	280	154	133	207		
H 0360-32	280	360	187	162	252		
H 0420-38	350	420	234	203	315		
H 0500-38	400	500	268	232	360		
H 0630-51	530	630	355	307	477		
H 0800-51	630	800	421	365	567		
H 1000-64	800	1000	535	464	720		
H 1200-64	950	1200	635	551	855		
H 1400-76	1080	1400	722	626	972		
H 1600-76	1200	1600	803	696	1080		
H 1800-76	1400	1800	936	812	1260		
H 2400-108	1780	2400	1191	1032	1602		

According to Austrian regulations

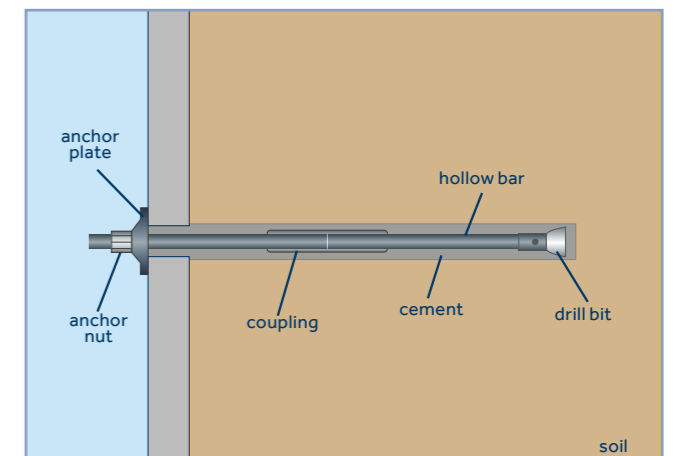

Soil nail with hollow bar



Corrosion protection systems

There are two types of corrosion protection systems available.

A standard corrosion protection system (SCP) involves encapsulation of the element in cement grout. This system is durable for compression loads. For tensile loads, additional corrosion

protection measures are required because of the potential for the cement grout to crack.

A double corrosion protection system (DCP) involves placing a corrugated sheath over the entire element and guarantees corrosion protection for up to 100 years.

For anchors

Temporary anchors do not need any special corrosion protection measures.

Due to their high steel grade, permanent anchors have to be assembled using a double corrosion protection (DCP) system.

For micropiles / soil nails

Temporary tension and / or compression micropiles and soil nails do not need any special corrosion measures.

There are then a number of ways to increase the life span of hot rolled solid and hollow bar steel elements:

- For compression piles, standard corrosion protection (SCP) will ensure a life span up to 100 years.
- For tension piles and soil nails, additional measures to limit crack width are required if they're to last longer than two years.
- Sacrificial thickness corrosion protection may be appropriate in ground conditions where corrosion is low allowing a life span up to approximately 50 years. This has limited application however in difficult ground conditions (eg salt and/or sulfate).

- Galvanised epoxy coating may be applicable as a semi-permanent corrosion protection system for solid bar systems with a life span up to 50 years. It cannot be used for hollow bar systems.
- Double corrosion protection (DCP) offers a permanent corrosion protection system for a life span up to 100 years or longer.
- Hollow bar systems are not available with a double corrosion protection (DCP) system.



Example of a Double Corrosion Protection System (DCP)

Applications

Anchors

Support for excavation and excavation pits

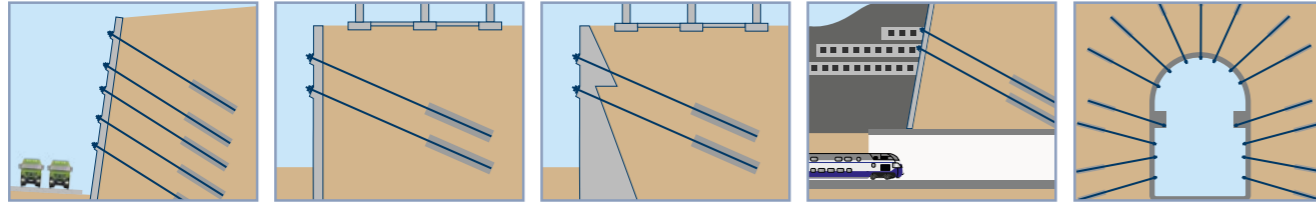

Slope stabilisation

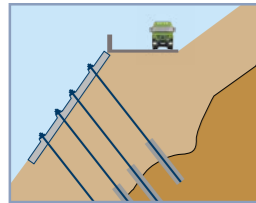

Micropiles

Foundation of buildings

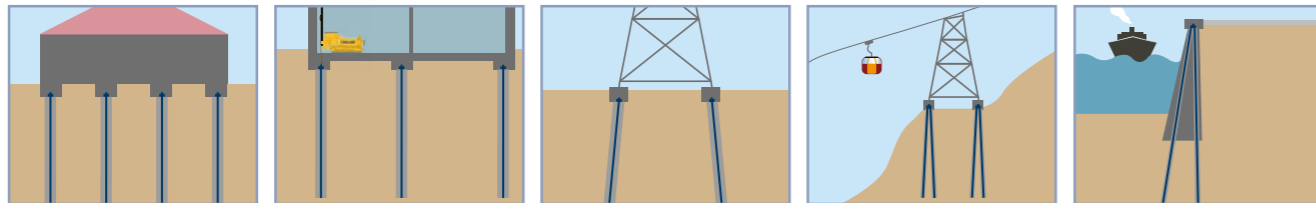

Excavation support

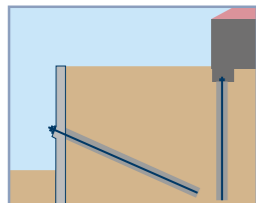

Uplift piles

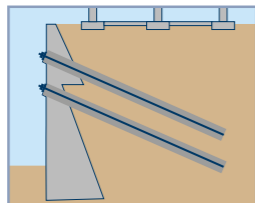

Tube umbrella

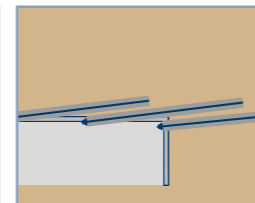
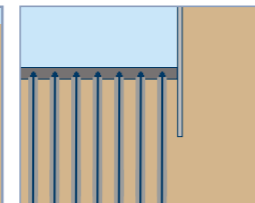

Soil and rock nails

Excavation support with soil nails and shotcrete

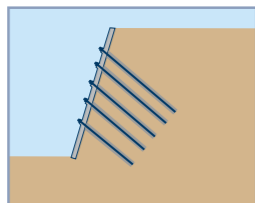
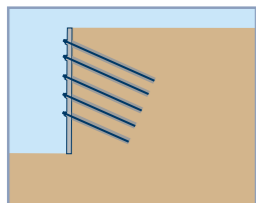

Soil nails and shotcrete to support excavations

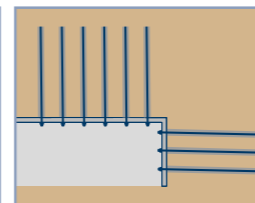
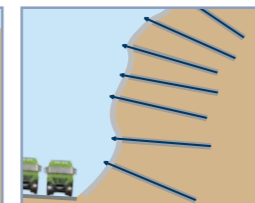

Small diameter drilling (SDD)

One advantage we have over many of our competitors is the wide range of drill tools and equipment we have available to execute micropile projects in every ground condition:

Our small diameter drilling (SDD) techniques include:

- Down the hole (DTH) drilling – water and air driven
- Double head systems
- Vibro or sonic drilling
- Any kind of auger and wash boring

We also have access to drill rigs between 1.5 and 50 tonnes for use in both confined spaces and open locations.





Testing

We test anchors, micropiles and soil nails that they perform as designed and can perform any static load test, investigation, suitability or acceptance test.

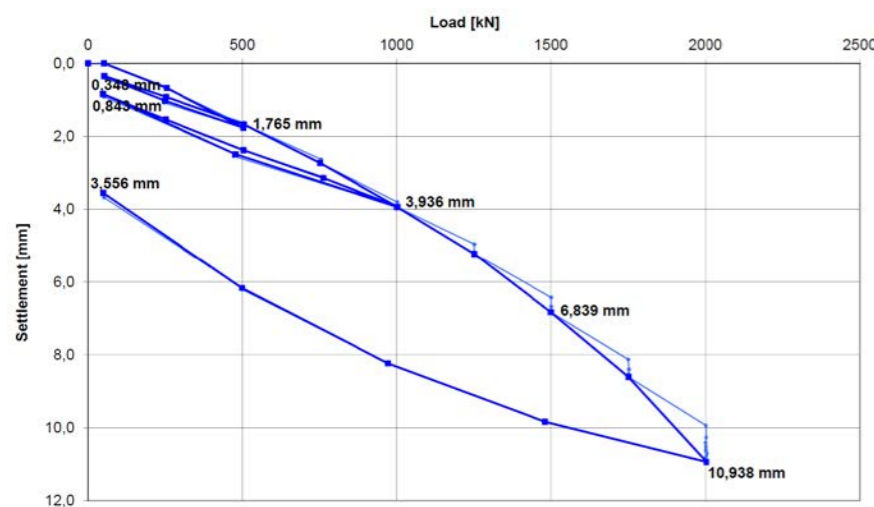
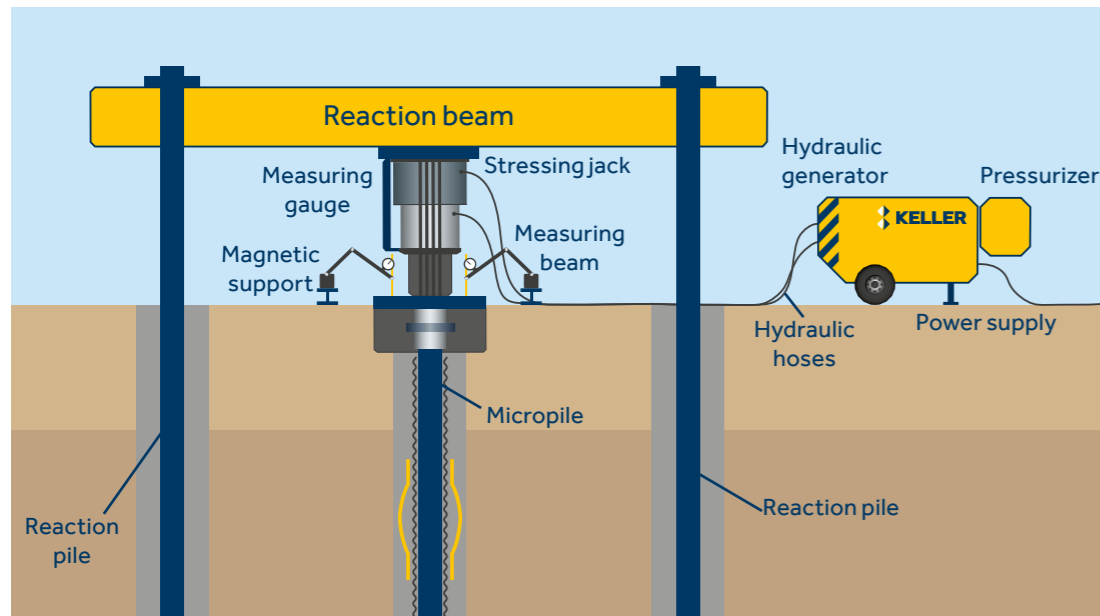

Compression piles:

- Static load test
- Analysis of load settlement behaviour

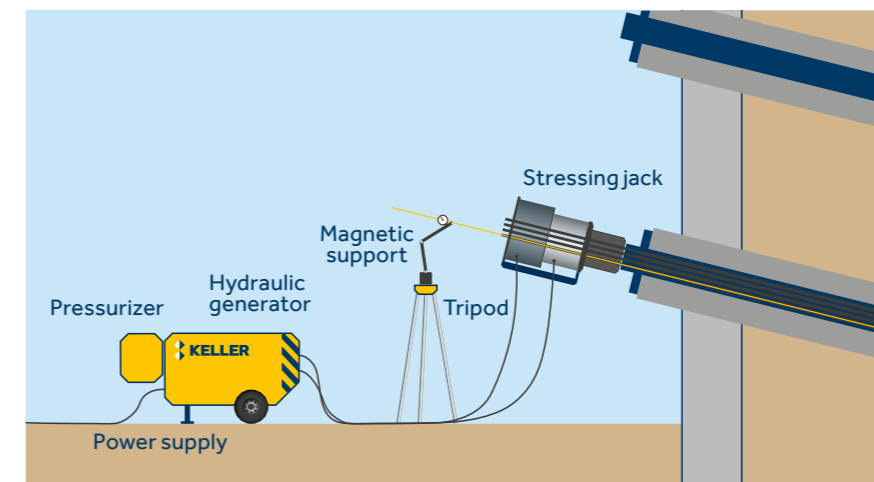

Ground anchors:

- Investigation test
- Suitability test
- Acceptance test

Tension piles / soil nailing:

- Static tension load test

Acceptance test: Load deformation curve

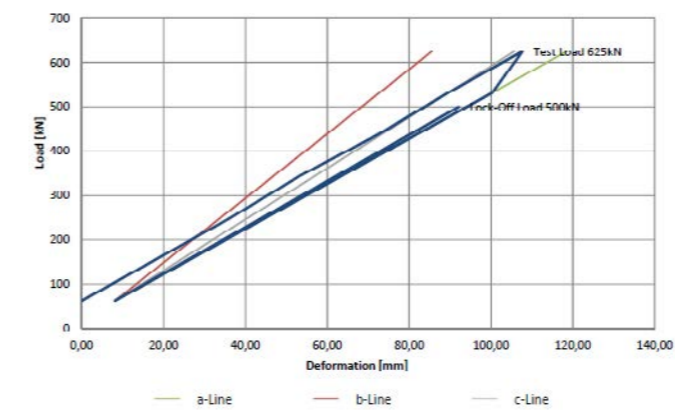

Suitability test: Determination of creep values

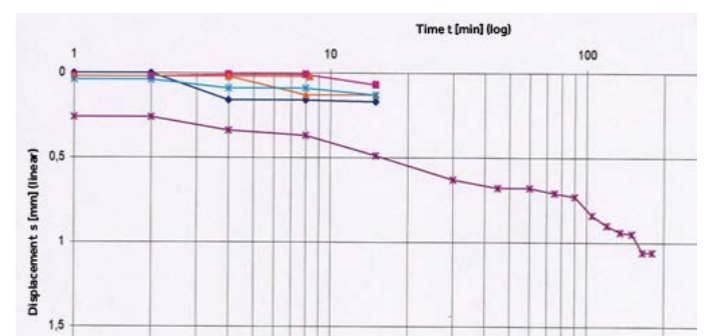



KW Gries water power plant

Excavation support for the construction of a hydroelectric power plant in Gries (Salzburg) using a bored pile wall, jet grouting as sealant between the piles, and 25m-long temporary strand anchors. Anchors were installed up to 7m below groundwater level.

Project example

A11 Highway – Karawankentunnel

Renovation work included permanent anchoring – using pre-stressed anchors – of the existing 20m-high support structures at the north entrance of the Karawanken tunnel. The anchors were up to 45 metres long with a tensile strength of Rk 2,700kN and Rk 2,100kN. The anchoring work was carried out from a drilling platform more than 20m above ground with a Klemm drill rig.





Keller Geoteknikk AS

Hovfaret 13, 0275 Oslo
Norway

info.no@keller.com
www.keller-geoteknikk.no/en